

SOUTHERN NEVADA BUILDING OFFICIALS
REGIONAL STANDARDS

B-114-1

7-7-14

PG. 1 OF 6

RESIDENTIAL ROOM ADDITION TYPICAL PLOT PLAN

Clark County
Dept. of Building & Fire Prevention
4701 W Russell Rd
Las Vegas, NV 89118
(702) 455-3000

Boulder City
Building Department
401 California Avenue
Boulder City, NV 89005
(702) 293-9282

Henderson
Bldg & Fire Safety Dept.
240 Water Street
Henderson, NV 89015
(702) 267-3650

Las Vegas
Building & Safety Dept.
333 N. Rancho Drive
Las Vegas, NV 89106
(702) 229-6251

- THIS IS ONLY AN EXAMPLE OF THE INFORMATION REQUIRED ON PERMIT APPLICATION DOCUMENTS. THIS IS NOT INTENDED TO BE A CONSTRUCTION DOCUMENT.
- PROVIDE TWO SETS OF PLANS
- PENCIL (ERASABLE) DRAWINGS ARE NOT ACCEPTABLE

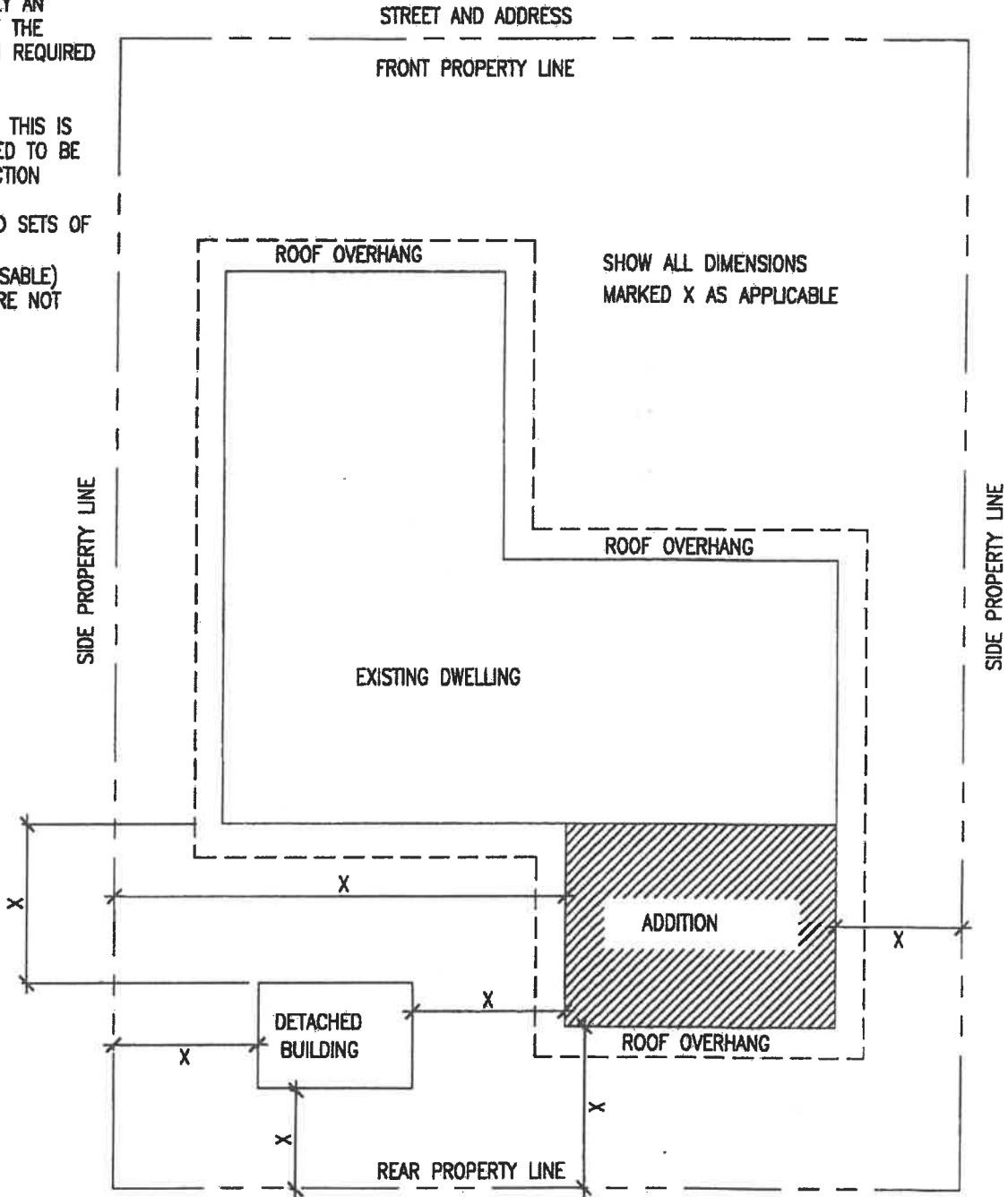

Mesquite
Building Department
10 East Mesquite Blvd.
Mesquite, NV 89027
(702) 346-2835

North Las Vegas
Building Department
2250 Las Vegas Blvd. N
N. Las Vegas, NV 89030
(702) 633-1577

Pahrump
Building & Fire Safet Dept.
250 N Hwy 160 Suite #3
Pahrump, NV 89060
(775) 751-3373

RESIDENTIAL ROOM ADDITION TYPICAL FLOOR PLAN

Clark County
Dept. of Building & Fire Prevention
4701 W Russell Rd
Las Vegas, NV 89118
(702) 455-3000

Boulder City
Building Department
401 California Avenue
Boulder City, NV 89005
(702) 293-9282

Henderson
Bldg & Fire Safety Dept.
240 Water Street
Henderson, NV 89015
(702) 267-3650

Las Vegas
Building & Safety Dept.
333 N. Rancho Drive
Las Vegas, NV 89106
(702) 229-6251

- SHOW EXISTING ROOMS ADJACENT TO NEW CONSTRUCTION WITH DIMENSIONS, WINDOW SIZES AND LOCATIONS, AND EXISTING ROOM USES.
- DESIGNATE IN SOME GRAPHIC FASHION THE NEW VERSUS EXISTING CONSTRUCTION. FOR EXAMPLE; DOUBLE-LINE WALLS AS EXISTING, SOLID WALLS AS NEW.
- FOR ALLOWABLE WINDOW TYPES AND MAXIMUM SIZES SEE CONSERVATION CODE QUICK COMPLIANCE GUIDE

CLOSET DEMOLISHED TO ALLOW INTERIOR ACCESS

NEW DOOR 3'0"x6'8"

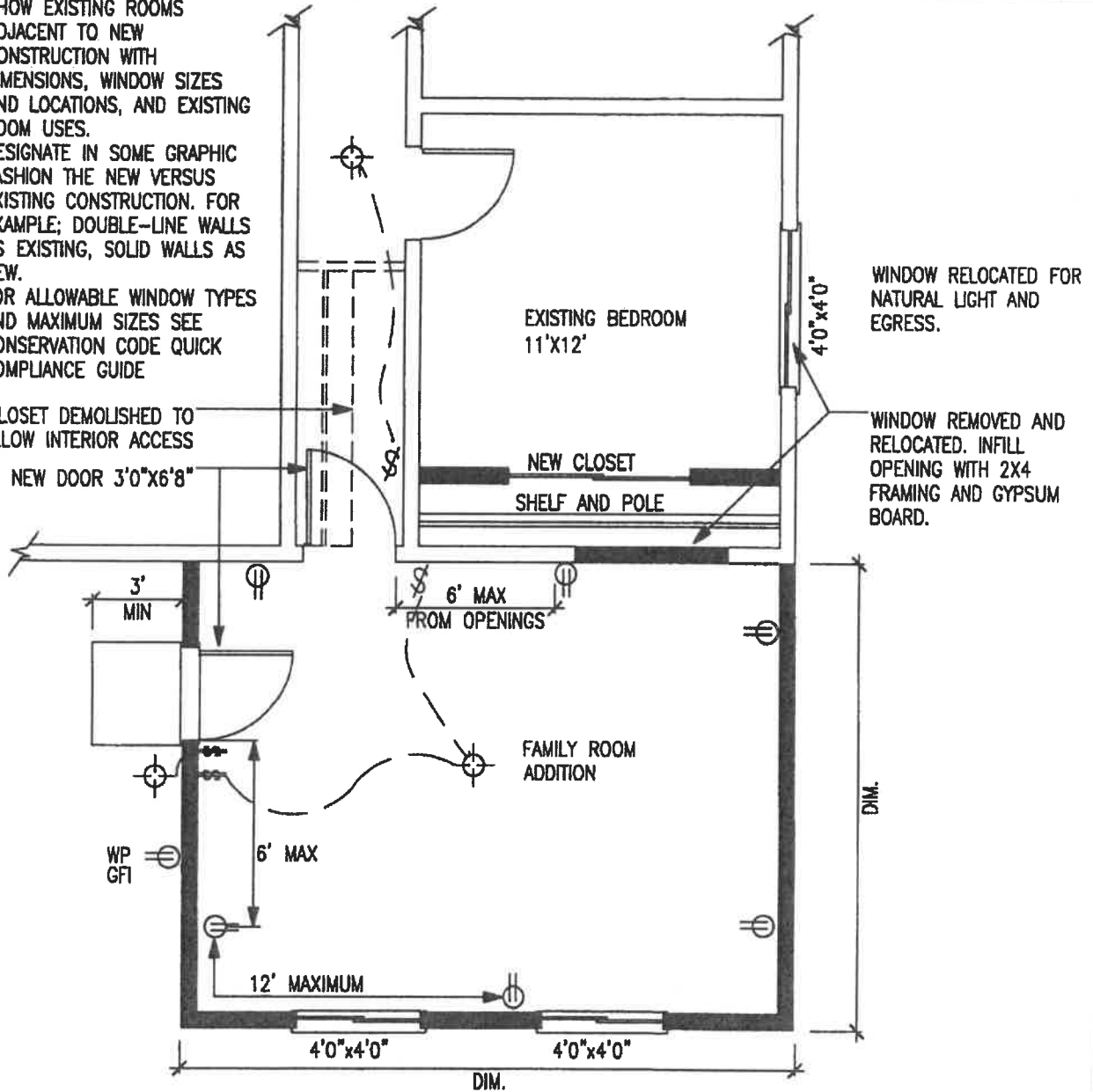

WINDOW RELOCATED FOR NATURAL LIGHT AND EGRESS.

WINDOW REMOVED AND RELOCATED. INFILL OPENING WITH 2X4 FRAMING AND GYPSUM BOARD.

EXISTING BEDROOM
11'x12'

NEW CLOSET
SHELF AND POLE

FAMILY ROOM
ADDITION

DIM.

DIM.

- PROVIDE 8% OF THE FLOOR AREA IN GLAZED OPENINGS (WINDOWS, GLASS DOORS, SKYLITES) IN ALL HABITABLE ROOMS. RELOCATE EXISTING REQUIRED GLAZING THAT IS REMOVED FOR REMODEL OR ADDITION. IN LIEU OF NATURAL LIGHTING ARTIFICIAL LIGHTING MAY BE PROVIDED CAPABLE OF PRODUCING 6 FOOT-CANDLES 30" ABOVE THE FLOOR
- GROUND FAULT CIRCUIT INTERRUPTERS ARE REQUIRED FOR KITCHENS, BATHROOMS, GARAGES, AND EXTERIOR OUTLETS.
- ARC-FAULT INTERRUPTERS ARE REQ. FOR ALL BEDROOMS, FAMILY ROOMS, DINING ROOMS, LIVING ROOMS, PARLORS, LIBRARIES, DENS, SUNROOMS, RECREATION ROOMS, CLOSETS, HALLWAYS, OR SIMILAR ROOMS OR AREAS, INCLUDING ALTERATIONS TO EXISTING BRANCH CIRCUIT WIRING.

Mesquite
Building Department
10 East Mesquite Blvd.
Mesquite, NV 89027
(702) 348-2835

North Las Vegas
Building Department
2250 Las Vegas Blvd. N
N. Las Vegas, NV 89030
(702) 633-1577

Pahrump
Building & Fire Safet Dept.
250 N Hwy 160 Suite #3
Pahrump, NV 89060
(775) 751-3373

RESIDENTIAL ROOM ADDITION TYPICAL FOUNDATION PLAN

Clark County
Dept. of Building & Fire Prevention
4701 W Russell Rd
Las Vegas, NV 89118
(702) 455-3000

Boulder City
Building Department
401 California Avenue
Boulder City, NV 89005
(702) 293-9282

Henderson
Bldg & Fire Safety Dept.
240 Water Street
Henderson, NV 89015
(702) 267-3650

Las Vegas
Building & Safety Dept.
333 N. Rancho Drive
Las Vegas, NV 89108
(702) 229-6251

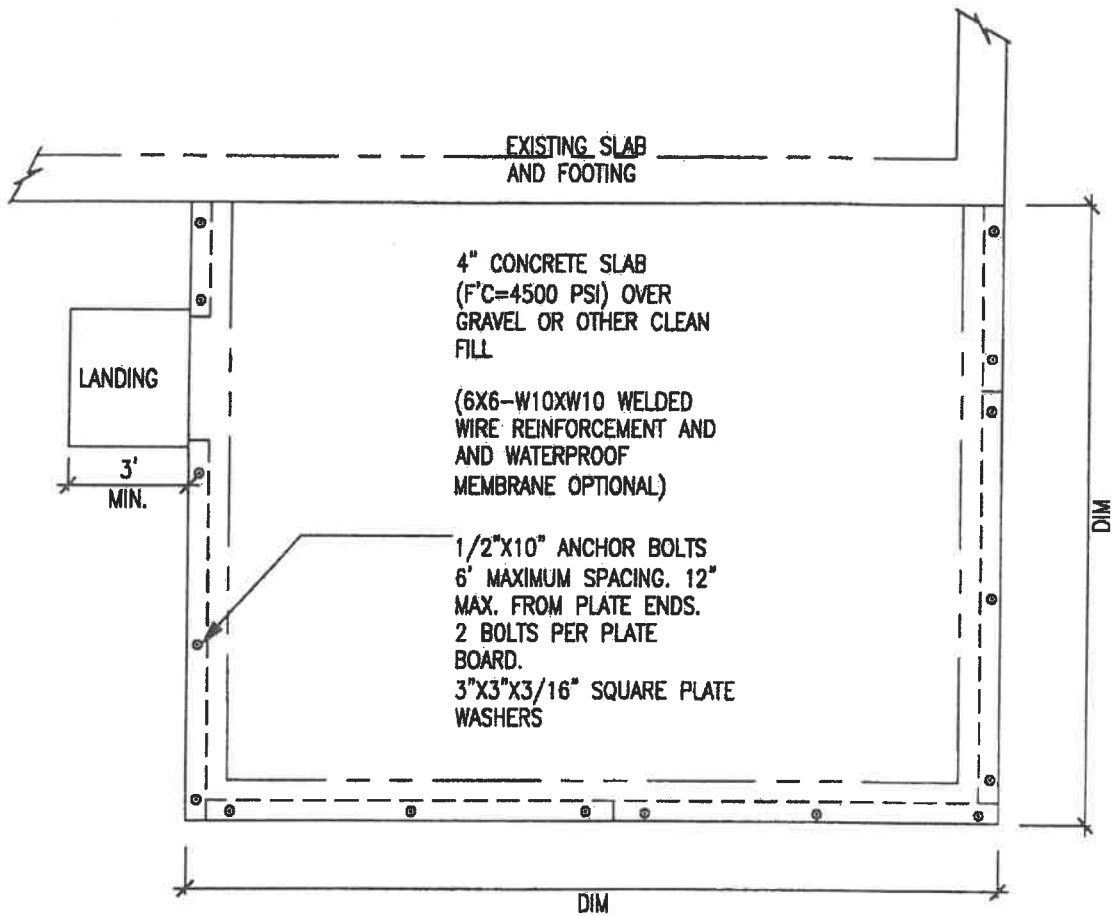

TYPICAL FOOTING CROSS SECTIONS

EXTERIOR BEARING WALL

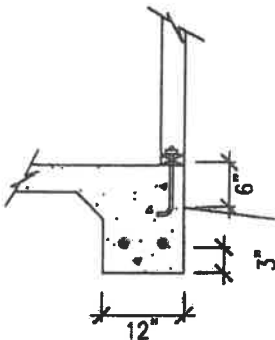

GARAGE RAISED CURB

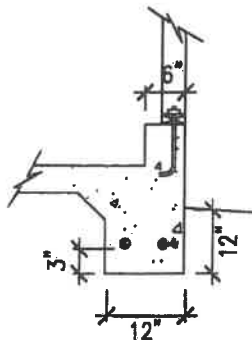

INTERIOR BEARING WALL

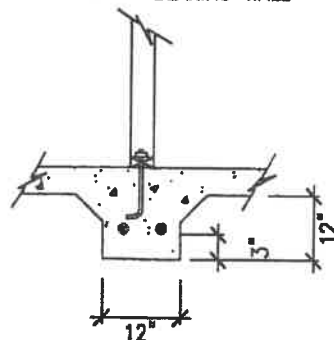

FOOTINGS REQUIRE 2 #4 REINFORCEMENT BARS LOCATED A MINIMUM OF 3" CLEAR FROM THE BOTTOM OF THE FOOTING.

Mesquite
Building Department
10 East Mesquite Blvd.
Mesquite, NV 89027
(702) 346-2835

North Las Vegas
Building Department
2250 Las Vegas Blvd. N
N. Las Vegas, NV 89030
(702) 633-1577

Pahrump
Building & Fire Safet Dept.
250 N Hwy 160 Suite #3
Pahrump, NV 89060
(775) 751-3373

RESIDENTIAL ROOM ADDITION TYPICAL CROSS SECTION

Clark County
Dept. of Building & Fire Prevention
4701 W Russell Rd
Las Vegas, NV 89118
(702) 455-3000

Boulder City
Building Department
401 California Avenue
Boulder City, NV 89005
(702) 293-9282

Henderson
Bldg & Fire Safety Dept.
240 Water Street
Henderson, NV 89015
(702) 267-3650

Las Vegas
Building & Safety Dept.
333 N. Rancho Drive
Las Vegas, NV 89106
(702) 229-6251

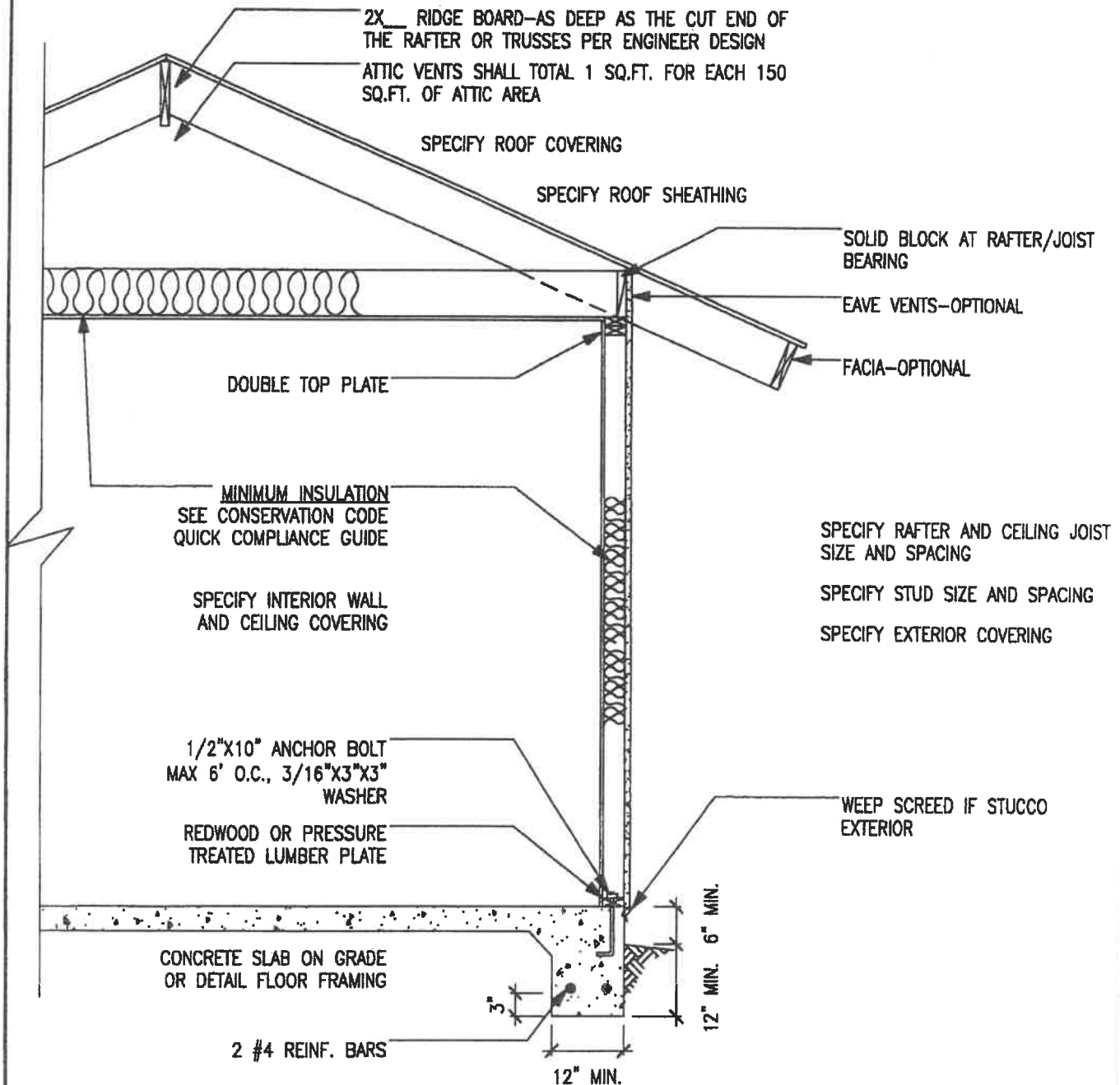

Mesquite
Building Department
10 East Mesquite Blvd.
Mesquite, NV 89027
(702) 346-2835

North Las Vegas
Building Department
2250 Las Vegas Blvd. N
N. Las Vegas, NV 89030
(702) 633-1577

Pahrump
Building & Fire Safet Dept.
250 N Hwy 160 Suite #3
Pahrump, NV 89060
(775) 751-3373

SOUTHERN NEVADA BUILDING OFFICIALS
REGIONAL STANDARDS

B-114-5

7-7-14

PG. 5 OF 6

RESIDENTIAL ROOM ADDITION TYPICAL ELEVATIONS

Clark County
Dept. of Building & Fire Prevention
4701 W Russell Rd
Las Vegas, NV 89118
(702) 455-3000

Boulder City
Building Department
401 California Avenue
Boulder City, NV 89005
(702) 293-9282

Henderson
Bldg & Fire Safety Dept.
240 Water Street
Henderson, NV 89015
(702) 267-3650

Las Vegas
Building & Safety Dept.
333 N. Rancho Drive
Las Vegas, NV 89106
(702) 229-6251

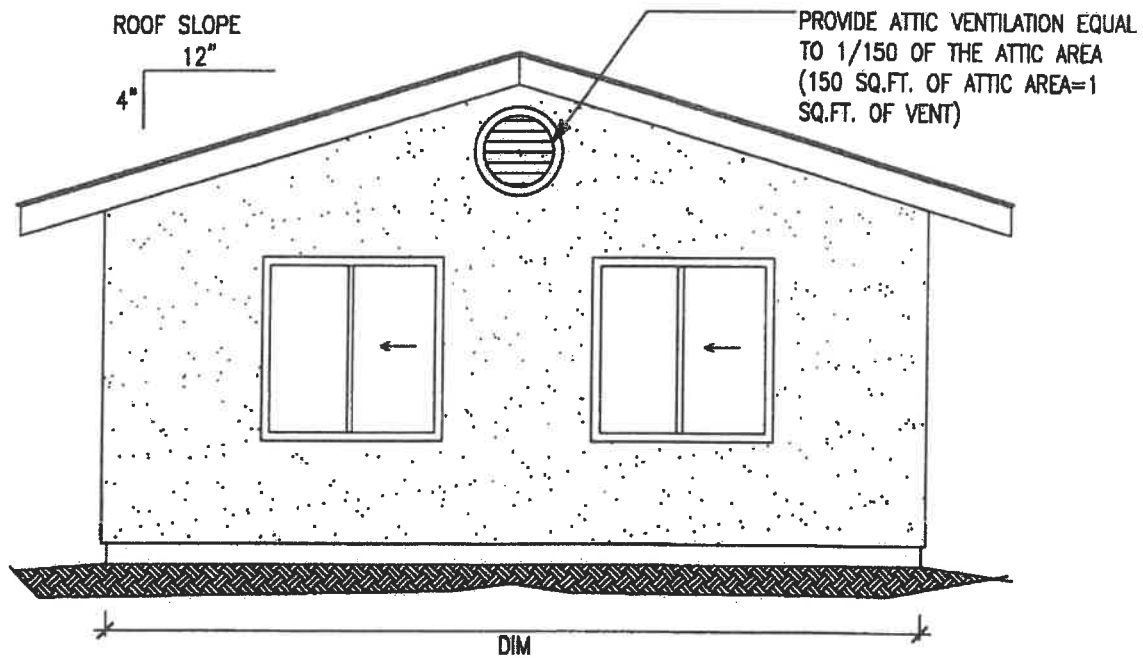
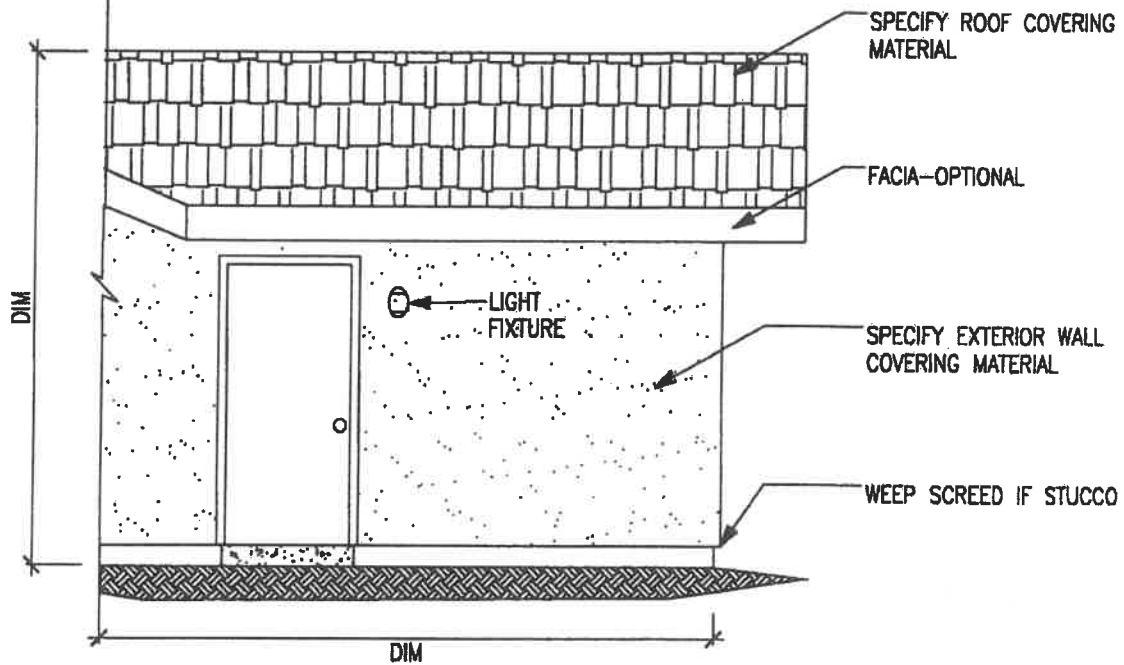

Mesquite
Building Department
10 East Mesquite Blvd.
Mesquite, NV 89027
(702) 346-2835

North Las Vegas
Building Department
2250 Las Vegas Blvd. N
N. Las Vegas, NV 89030
(702) 633-1577

Pahrump
Building & Fire Safet Dept.
250 N Hwy 160 Suite #3
Pahrump, NV 89060
(775) 751-3373

RESIDENTIAL ROOM ADDITION TYPICAL FRAMING PLAN

Clark County

Dept. of Building & Fire Prevention
4701 W Russell Rd
Las Vegas, NV 89118
(702) 455-3000

Boulder City

Building Department
401 California Avenue
Boulder City, NV 89005
(702) 293-8282

Henderson

Bldg & Fire Safety Dept.
240 Water Street
Henderson, NV 89015
(702) 267-3650

Las Vegas

Building & Safety Dept.
333 N. Rancho Drive
Las Vegas, NV 89106
(702) 229-6251

ROOF FRAMING PLAN

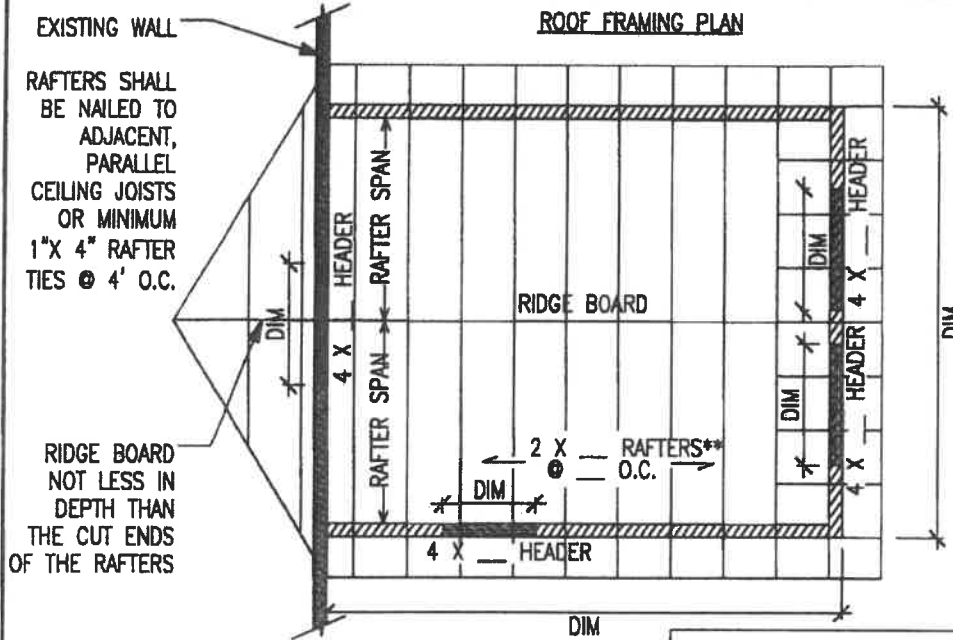

1. CALL OUT THE DIMENSIONS OF ALL NEW OPENINGS.
2. CALL OUT THE LOCATIONS AND DIMENSIONS OF ALL BRACED WALL PANELS (INCLUDING AT THE EXISTING WALL).
3. ADD ADDITIONAL BRACED WALL PANELS AT THE EXISTING WALL, AS NEEDED.
4. NEW OPENINGS IN EXISTING BRACED WALL PANELS MAY REQUIRE ENGINEERING.
5. CALL OUT ALL HEADER SIZES.

**OR APPROVED MANUFACTURED TRUSSES

FLOOR FRAMING PLAN IF CRAWLSPACE

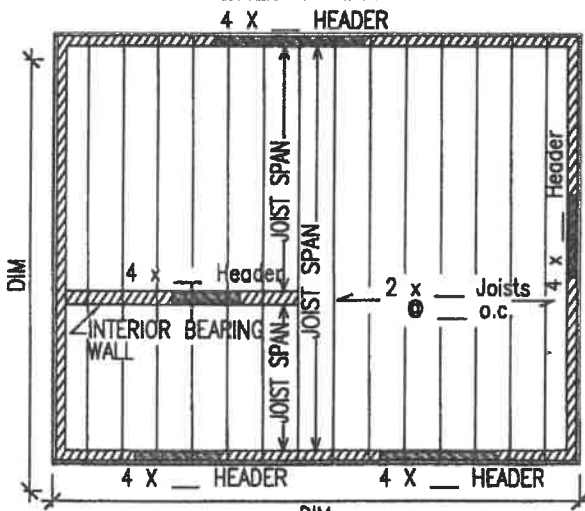

SHOW LENGTH OF ALL HEADERS

RAFTERS SIZES BASED ON 2012 IRC:
CEILING JOIST TABLE R802.4(2)
ROOF RAFTER TABLE R802.5.1(2)
FLOOR JOIST TABLE R902.3.1(2)

*THE TABULATED ROOF RAFTER SPANS ASSUME THAT CEILING JOISTS ARE LOCATED AT THE BOTTOM OF THE ATTIC SPACE OR THAT SOME OTHER METHOD OF RESISTING THE OUTWARD PUSH OF THE RAFTERS OR THE BEARING WALLS, SUCH AS RAFTER TIES, IS PROVIDED AT THAT LOCATION.

*RAFTERS & JOIST SPAN TABLE BASED ON DOUGLAS FIR/LARCH #2

SIZE	SPACING	FLOOR JOIST MAX SPAN	CEILING JOIST MAX SPAN	ROOF RAFTER MAX SPAN
2x4	12"		9'-10"	-
2x4	16"		8'-9"	-
2x4	24"		7'-2"	-
2x6	12"	10'-6"	14'-10"	14'-4"
2x6	16"	9'-1"	12'-10"	12'-5"
2x6	24"	7'-5"	10'-6"	10'-2"
2x8	12"	13'-3"	18'-9"	18'-2"
2x8	16"	11'-6"	16'-3"	15'-9"
2x8	24"	9'-5"	13'-3"	12'-10"
2x10	12"	16'-3"	22'-11"	22'-3"
2x10	16"	14'-1"	19'-10"	19'-3"
2x10	24"	11'-6"	16'-3"	15'-8"
2x12	12"	18'-10"	-	25'-9"
2x12	16"	16'-3"	-	22'-4"
2x12	24"	13'-4"	-	18'-3"

Mesquite

Building Department
10 East Mesquite Blvd.
Mesquite, NV 89027
(702) 346-2835

North Las Vegas

Building Department
2250 Las Vegas Blvd. N
N. Las Vegas, NV 89030
(702) 633-1577

Pahrump

Building & Fire Safat Dept.
250 N Hwy 160 Suite #3
Pahrump, NV 89060
(775) 751-3373